



**Opto Plus LED Corp.**  
**0.6" Case Mold Type LED Display**  
**OPD-S6010LB | OPD-S6011LB**

● **EDIT HISTORY**

Version A: Nov. 04, 2020

Preliminary Spec.



# Opto Plus LED Corp.

## 0.6" Case Mold Type LED Display

### OPD-S6010LB | OPD-S6011LB

#### ● FEATURES

- 0.6 inch (15.0 mm) Digit Height.
- Low current operation.
- Case mold type.
- RoHS compliant, Pb Free.

#### ● DESCRIPTION

The device are 0.6 inch (15.0 mm) height single digit 7-segment displays.

The device is Opto Plus LED Corp standard LED Display.

This device utilizes Super Bright Blue LED chip which are made from InGaN on a transparent GaN substrate.

The device has face and segment option, please refer to **PRODUCT APPEARANCE**.

#### ● DEVICE

	PART NO.	DESCRIPTION
	OPD-S6010LB-GW	Common Anode   Gray face   White segment
	OPD-S6011LB-GW	Common Cathode   Gray face   White segment
	OPD-S6010LB-BW	Common Anode   Black face   White segment
	OPD-S6011LB-BW	Common Cathode   Black face   White segment

#### RoHS Compliance



#### Pb Free.



### MECHANICAL DIMENSIONS

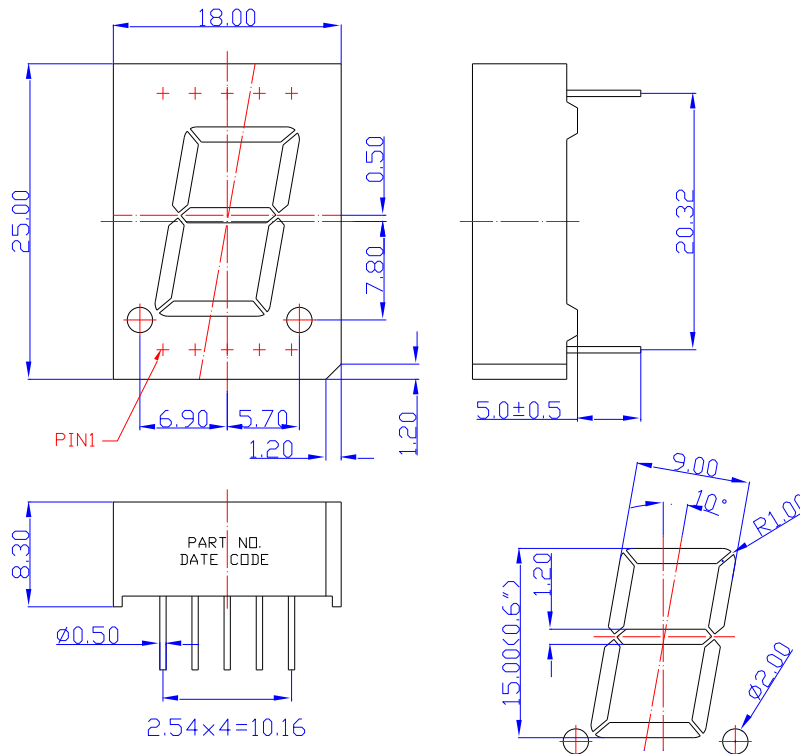

NOTES: Dimension is in millimeters. Tolerance is  $\pm 0.25$  mm unless otherwise noted.

### TYPICAL INTERNAL EQUIVALENT CIRCUIT

Turn On Color

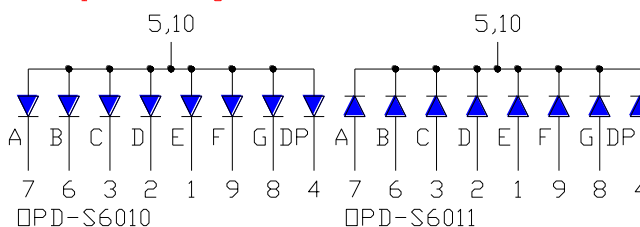
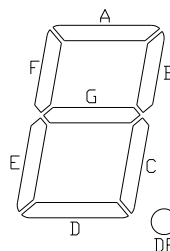
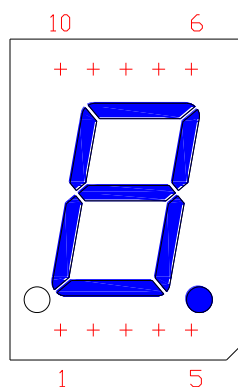

※EMITTED COLOR : SUPER BRIGHT BLUE



# Opto Plus LED Corp.

## 0.6" Case Mold Type LED Display

### OPD-S6010LB | OPD-S6011LB

#### ● LB: SUPER BRIGHT BLUE (InGaN/GaN)

ABSOLUTE MAXIMUM RATING AT Ta=25°C

Parameter	Symbol	Maximum Rating	Unit
Power dissipation	P <sub>AD</sub>	68	mW
Continuous forward current	I <sub>AF</sub>	20	mA
Peak current (duty cycle 1/10, 1kHz)	I <sub>PF</sub>	60	mA
Reverse voltage	V <sub>R</sub>	5	V
Operating temperature	T <sub>OPR</sub>	-40 to +85	°C
Storage temperature	T <sub>STG</sub>	-40 to +85	°C

ELECTRICAL - OPTICAL CHARACTERISTICS AT Ta=25°C

Characteristic	Symbol	Condition	Min.	Type.	Max.	Unit
Forward Voltage	V <sub>F</sub>	I <sub>F</sub> =20mA	-	3.0	3.4	V
Reverse Current	I <sub>R</sub>	V <sub>R</sub> =5V	-	-	10	μA
Dominant Wavelength	λ <sub>D</sub>	I <sub>F</sub> =20mA	460	465	475	nm
Luminous Intensity	I <sub>V</sub>	I <sub>F</sub> =20mA	-	60	-	mcd
Spectral Line Half-Bandwidth	Δλ	I <sub>F</sub> =20mA	-	20	-	nm



# Opto Plus LED Corp.

## 0.6" Case Mold Type LED Display

### OPD-S6010LB | OPD-S6011LB

## ● PRODUCT APPEARANCE

The most common reflector color and segment color are show in below diagram.

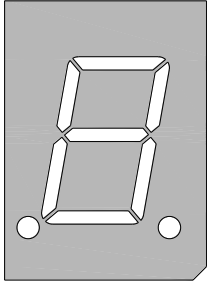
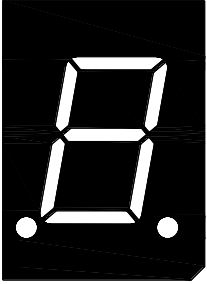
-GW	-BW
	
※ REFLECTOR COLOR: Gray ※ SEGMENT COLOR: White	※ REFLECTOR COLOR: Black ※ SEGMENT COLOR: White

Opto Plus can customize reflector and segment colors by customer's request. If you have these request please visit [www.opledtw.com](http://www.opledtw.com) or contact [sales@opledtw.com](mailto:sales@opledtw.com) for more **Standard Product Customization** information.

Part NO. related to reflector and segment colors show as table below.

PART NO.	DESCRIPTION
OPD-S6010LB-GW	Common Anode   Gray face   White segment
OPD-S6011LB-GW	Common Cathode   Gray face   White segment
OPD-S6010LB-BW	Common Anode   Black face   White segment
OPD-S6011LB-BW	Common Cathode   Black face   White segment

### ● LB: SUPER BRIGHT BLUE (InGaN/GaN) CURVE

Typical Electro-optical Characteristic Curves  
(25 °C Free Air Temperature Unless Otherwise Specified)

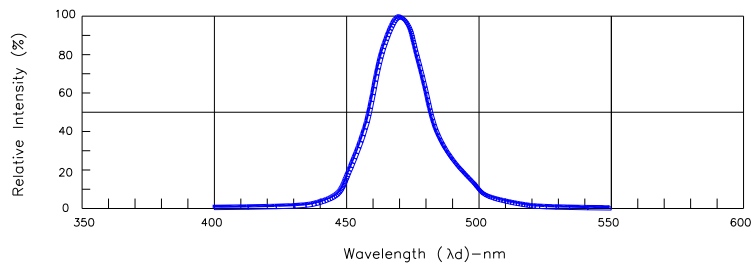

Fig.1-Relative Intensity VS. Wavelength

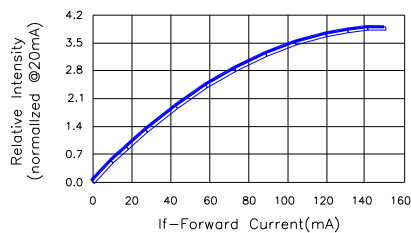

Fig.2-Relative Luminous Intensity vs. Forward Current

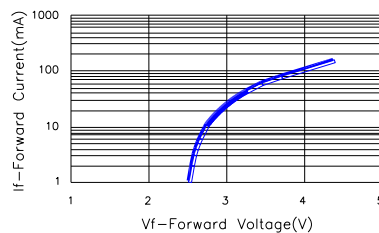

Fig.3-Forward Current vs. Forward Voltage

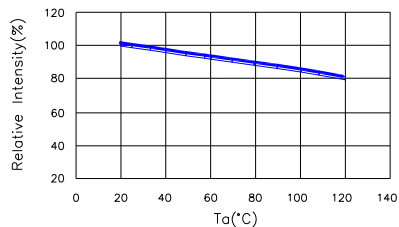

Fig.4-Relative Intensity(@20mA)VS. Ambient Temperature

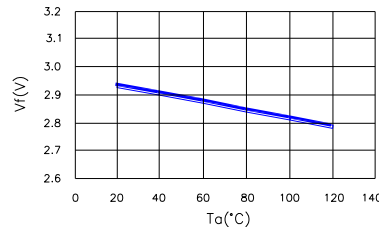

Fig.5-Forward Voltage(@20mA)VS. Ambient Temperature

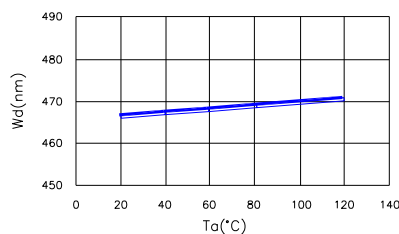

Fig.6-Dominant Wavelength(@20mA)  
VS. Ambient Temperature

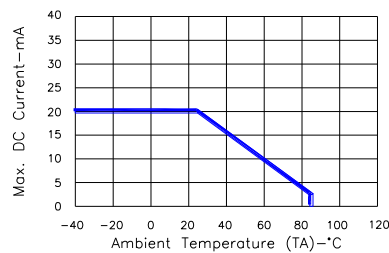
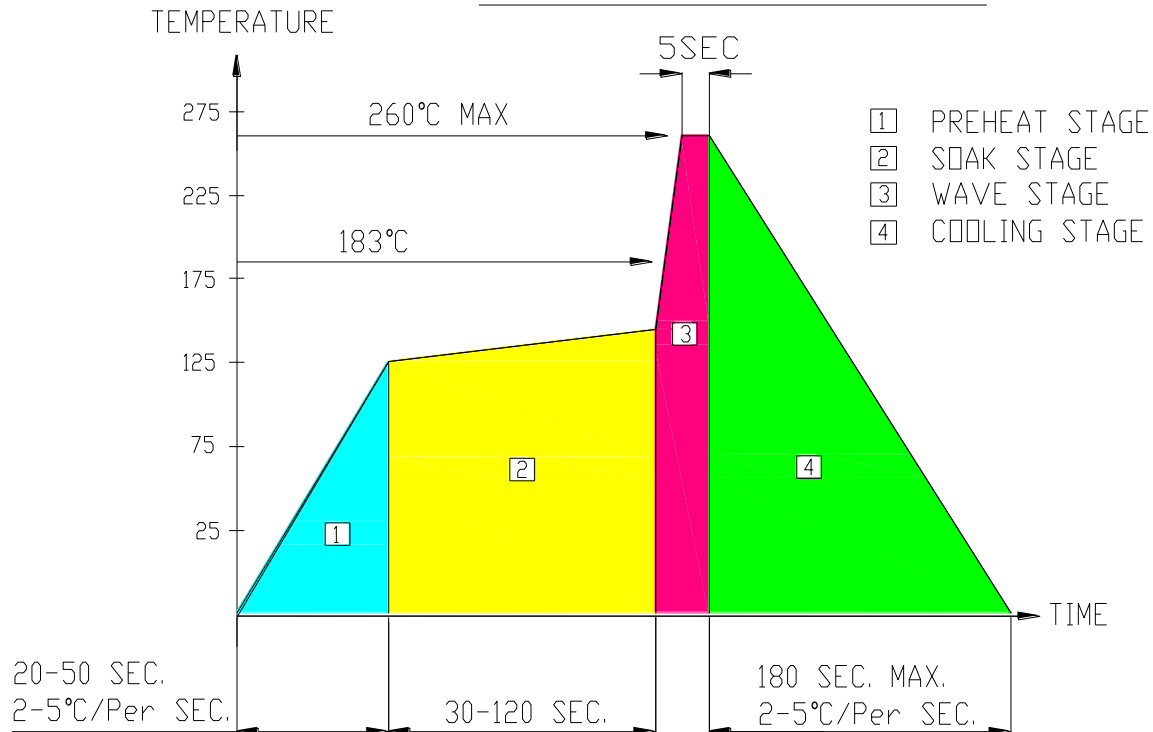

Fig.7-Max. Allowable DC Current  
VS. Ambient Temperature

## ● RECOMMEND SOLDERING PROFILE

### WAVE SOLDER PROFILE



## ● Note:

- Recommend pre-heat temperature of 105°C or less (as measured with a thermocouple attached to the LED pins) prior to immersion in the solder wave with a maximum solder bath temperature of 260°C
- Peak wave soldering temperature between 245°C ~ 225°C for 3 sec (5 sec max)
- No more than one wave soldering pass

## ● SOLDERING IRON

Basic spec is  $\leq 4$  sec when 260°C. If temperature is higher, time should be shorter (+10°C → 1 sec). Power dissipation of Iron should be smaller than 15W, and temperature should be controllable. Surface temperature of the device should be under 230°C.

## ● REWORK

Customer must finish rework within  $\leq 3$  sec under 350°C.  
The head of soldering iron cannot touch copper foil.